

jWIN®

JC-CD260

Instruction Manual

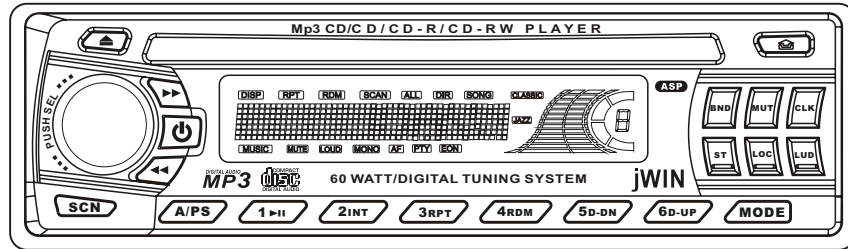

CAR CD 12/45SEC / Mp3 120SEC ASP PLAYER

RECEIVER (AM/FM)

DETACHABLE FRONT PANEL

FUNCTION OF CONTROLS

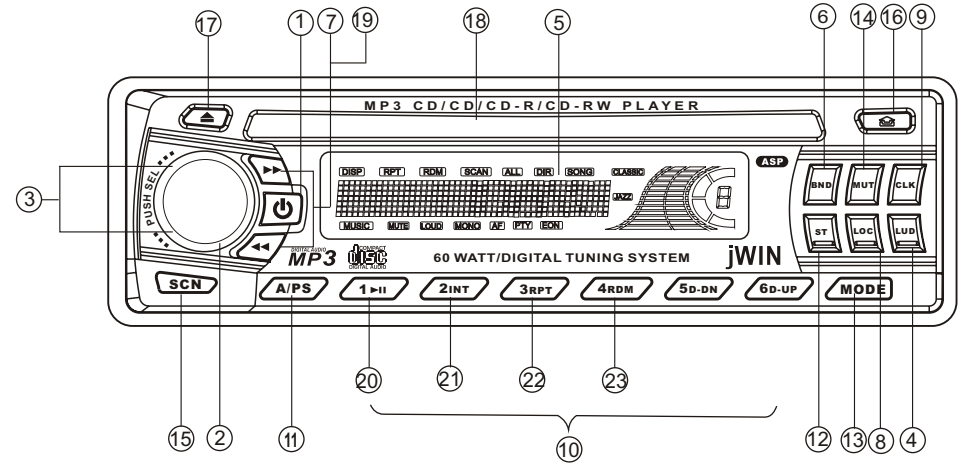

CONTROL FUNCTIONS

1. POWER ON/OFF

Press any key to power up the unit.

Press this key for more than 1 second to turn off unit.

2,3. SEL (control mode select)/MENU KEY

Push to select the desired mode, VOL(volume), BAS(bass), TRE(treble) BAL(balance), or FAD(fader).

This button normally functions as the volume control. Adjust the level rotate(3) after selecting the desired control mode. Otherwise the mode will go back to the volume control mode.

Control Mode	Turn clockwise:	Turn counter clockwise:
Volume control	For less volume	For more volume
Bass control	For less bass	For more bass
Treble control	For less treble	For more treble
Balance control	To decrease the right speaker volume	To increase the left speaker volume
Fader control	To decrease the front speaker volume	To increase the rear speaker volume

MENU KEY

Hold the SEL key to choose the menu.

1) menu1: AUDIO DSP FUNCTION

Press and hold longer than one second to activate the DSP feature. Rotate the SEL knob to select DSP mode sound effect as shown in sequence below. User setting value of bass/treble in normal mode is always memorized. In rock/classic/pops mode, bass/treble mode is skipped and level is not changeable

FLAT---CLASSICS---POP M---ROCK M---DSP OFF.

Bass and Treble gain of each mode is as shown in below table.

Initial value of bass/treble in NORMAL mode is 0 dB.

	LCD DISPLAY	BASS (F=100HZ)	MID (F=1KHZ)	TREBLE (F=10KHZ)
NORMAL	DSP OFF	X dB	0 dB	X dB
FLAT	FLAT M	0 dB	0 dB	0 dB
ROCK	ROCK M	6 dB	0 dB	2 dB
CLASSIC	CLASSIC M	2 dB	0 dB	2 dB
POP	POP M	-4 dB	0 dB	-2 dB

2) menu2:BEEP ON--BEEP OFF

The situation of beep sound is selected.The 2 mode is selected as also vol up or vol dn key.

BEEP ON mode: A beep sound is generated when each key is pressed.
BEEP OFF mode: The beep sound is disabled.

3) menu3:VOL LAST--VOL Addition

VOLUME LEVEL is determined when POWER ON

LAST VOLUME:Final VOLUME LEVEL generates power before power off.
ADJUST VOLUME:VOLUME LEVEL selected by the user is produced.

4) menu4:SEEK1--SEEK2

SEEK1:SEEK is activated right away when key is pressed for longer than 500ms.
SEEK2:SEEK is activated after key is released.

5) menu5:ESP12--45 OPTION

THE ANTI-SKIP PROTECTION FUNCTION (ASP)

While in use,the player is likely to receive shocks or vibrations.The ANTI-SHOCK FUNCTION is active to provide uninterrupted playback.

Should the player receive shocks for more than 45 seconds continuously in cd playback or 120 seconds in mp3 playback,the sound will mute for a very short while and will resume once the player has stabilised from the shock.

ESP12:Selected ESP time 12 seconds.
ESP45:Selected ESP time 45 seconds.

6) ENTER>User can select track/files and do character search while in Mp3 MODE.

4. LOUDNESS BUTTON

-Press this button to boost the bass and treble response.Push the button again to return to normal operation.This function is useful when listening at low levels.loudspeakers are inefficient at low power levels and will tend to sound flat.The loudness control will boost the bass and treble response thus giving a more lively performance.

While this function is operating,the display shows LUD.

5. LCD DISPLAY

-The liquid crystal display will display the current status of the unit.

6. BAND SELECTOR SWITCH

Press this switch to select the desired Radio band.Selection is made in regular sequence as FM-AM.

7. AUTOMATIC OR MANUAL TUNING(FREQ UP>>OR FREQ DOWN<<)

(A) RADIO MODE

When pressed for less than 1 second,these keys operate as manual tuning mode.
When pressed longer than 1 sec.,they are operated as SEEK tuning mode.(AUTO)

(B) CD PLAYER MODE

When pressed for less than 1 second,these keys operate as TRACK UP or TRACK DOWN.
When pressed longer than 1 sec.,they will operate as CUE or REVIEW mode.

8. LOCAL/DISTANT BUTTON

Press local/distant(LO/DX) button for listening to weak stations.LOC indicator will appear on the display.
Press this button again (Distant mode) for normal operation.

8. LOCAL/DISTANT BUTTON

Press local/distant(LO/DX) button for listening to weak stations.LOC indicator will appear on the display.
Press this button again (Distant mode) for normal operation.

9. DISPLAY BUTTON (Set the Clock)

Selects radio frequency or clock display.

To set the clock:

- 1.With clock display selected,hold down the (CLK) button until clock display starts flashing.
- 2.Press (-) to change minutes,(+) to change hours.
- 3.Press (CLK) button to start the clock.

10. PRESET STATIONS

Six numbered preset button store and recall stations for each band.

Storing station

- 1.Select a band (if needed)
- 2.Select a station
- 3.Hold a preset button longer than one second.Preset station number appears in the display when station is saved.

Recall a station:

- 1.Select band (if needed)
- 2.Press a preset button for less than one second to select stored station.

11. AUTOMATICALLY STORE STATIONS

Select six stations and store them in current band.

- 1.Select a band (if needed)
- 2.Hold **A/PS** button for more than three seconds.The new station replace stations already stored in that band.

Preset A/PS

- 1.Select a band (if needed)
- 2.Touch A/PS for more than one second but less than three seconds.Radio pauses for five seconds at each station.Touch A/PS again to stop scanning when the desired station is reached.

12. STEREO/MONO SELECTOR

This function will only affect FM reception.Press this button if the FM reception becomes noisy/hissy.
If the station being received is in stereo,it will now be played in mono.Press this button again to return the receiver to normal reception

13.MODE BUTTON (MODE)

By pressing this key,user can select RADIO mode,AUX mode,CD PLAYER mode.

14.MUTE BUTTON

Press the MUTE button to stop and the LCD will flash "MUTE".
To stop this function press again the same button.

15. SCAN BUTTON

Press this button briefly (LESS THAN 2 SEC.)and the radio will tune to the next memory preset station, pausing for 6 seconds, and repeating the process endlessly until a selection is made.

To stop scanning, press this button briefly once again, or press the preset button that corresponds to the channel number blinking on display.

16.PANEL RELEASE BUTTON

Press the  button and the right-side section of the panel will release.

CD CONTROL LOCATION OF PARTS

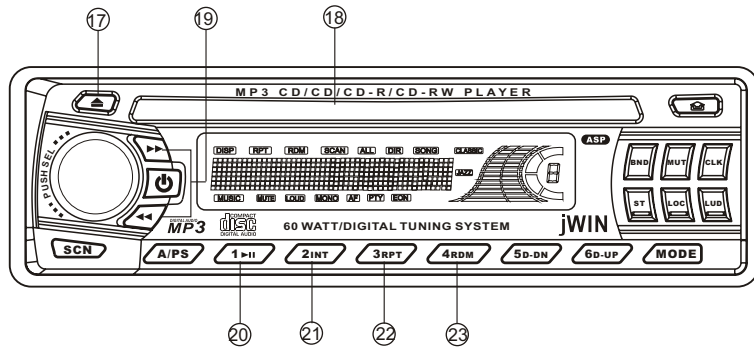

17.CD EJECT BUTTON

Press the EJECT button to remove the CD.The receiver will automatically switch to radio mode.

18.CD SLOT

19.TRACK/SEARCH BUTTON FORWARD AND REVERSE TRACK SEARCH

Press the SKIP button << or >> during play to go to the desired track(song).

(<< ...REVERSE)(>>...FORWARD)

Press and hold the SKIP button << or >> during play to scan the disc at high speed.When the desired music section of the disc is found,release the button.Normal play will resume.

20.PAUSE BUTTON

During PLAY press >|| button to PAUSE.Press it again to resume play.

21.INT BUTTON (Preview all Tracks)

This feature allows you to listen to the first 10 seconds of each track on the display .Press the key SCAN indicator appears on the LCD panel.

To cancel the function press the key again.

22.REPEAT BUTTON (RPT)

To repeat the current track press the key.The RPT indicator appears on the LCD panel and the track be repeated continuously.

To cancel the function press the key again.

23.RANDOM BUTTON (RDM)

Press the key. Track will be palyed in randomorder.

To cancel the function press the key again.

AS/PS is the Digital Audio Mode selection key (Mp3)

When pressed,it selects the mode of Digital Audio.

Search track directly -----Search File or directory----- Search character name

1. Search tracks directly in digital audio Mp3.

TRACK SEARCH EXAMPLE

1.How to find track number 133,Title name ABC .mp3

a.Press SEARCH key to go to TRACK search mode.

The LCD,displays first digit, 001.

b.Press ENTER(SEL/MENU)to accept 1 digit 1,then LCD will show 010. 1ST digit 1 is selected.

c.Then press SEARCH UP (VOL+) key 3 times,then 2 digit will increase according to the numb er of times key is pressed.

D.If LCD shows 013 then ,press ENTER key again. Then 2ND digit is selected.LCD will show 130.

e.Third digit 0 is displayed.Then press SEARCH UP key 3 times to enter 3RD digit to 3.

f.Press ENTER key LCD shows 133.The track number is selected and ready to be played.

g.Finally press ENTER,then track number 133 will play immediately.

f.SEARCH UP/DOWN key perform to shift number from 0-9 as a loop rotation.

FILE SEARCH EXAMPLE

If the structure of Disc above has Mp3 TOC,it is as follows.

Total Dir:4 Total song:7

Dir of Mp3 files:3 (A,C,D)

We regard Dir as Mp3 file. When operating it is located as A---C---D---A...

To listen to a song from Mp3 (ON Normal play)

1.Press search key (2 times) [file search mode displays.]

2.Press enter key [-A- Dir display.]

3.Press search down key (2 times) [-D- Dir displays.]

4.Press enter key (1 times) [-e- file displays.]

5.Press search down key (1 times) [-f- file displays.]

6.Press enter key [-F- Mp3 file plays start.]

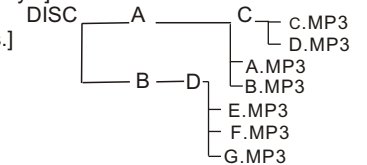

CHARACTER SEARCH EXAMPLE

If the structure of Disc above has MP Toc,it is as follows

Total Dir:4 Total song:7

Dir to have Mp3 files:3 (A,C,D)

To listen to a song from Mp3 (On normal play)

1.Press search key (3 times) [character search mode displays.]

2.Press enter key [-character A displays in the 1ST digit.]

3.Press search down key (4 times) [-character E displays.]

4.Press enter key (1 times) [-character EA displays.]

5.Press search down key (2 times) [-character EC displays.]

6.Press enter key [-character ECA displays.]

7.Press search down key (7 times) [-character ECH displays.]

8.Press enter key [-character ECHA displays.]

9:Press search down key (14 times) [-character ECHO displays.]

10:Hold enter key for longer than 0.5sec, ECHO file begin playing.

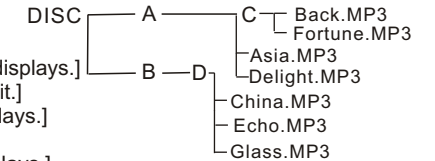

M5 DN M6 UP IS ASSIGNED AS 10 TRACK when normal play and searching file or directory.

HOW TO REMOVE AND INSTALL THE FRONT PANEL

1. Press the release button and pull-off the front panel.
2. To install the front panel, insert the panel into the housing and make sure the panel is securely installed, otherwise, abnormalities occur on the display or some keys will not function properly.

PRECAUTIONS

- Do not touch the contacts on the front panel or on the unit body, since this may result in poor electrical conductivity. If dirt or other foreign substances get on the contacts, wipe them with a clean dry cloth.

PRECAUTIONS WHEN HANDLING THE FRONT PANEL

- Do not leave the front panel in any area exposed to high temperatures or direct sunlight.
- Do not drop the front panel or otherwise subject it to strong impact.
- Do not allow such volatile agents as benzene, thinner, or insecticides to come into contact with the surface of the front panel.
- Never try to disassemble the front panel.

REMOVING THE FRONT PANEL

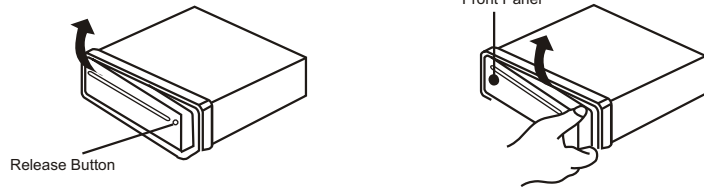

INSTALLING THE FRONT PANEL

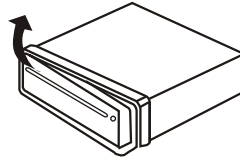

INSTALLATION

NOTE:

- Choose the mounting location where the unit will not interfere with normal driving function. Before finally installing the unit, connect the wiring temporarily and make sure it is all connected properly and the unit and the system work properly. Use only the parts included with the unit to ensure proper installation. The use of unauthorized parts can cause malfunctions. Consult with your nearest dealer if installation requires the drilling of holes or other modifications of the vehicle. Install the unit where it does not get in the driver's way and cannot injure the passenger if there is a sudden stop. Like an emergency stop. If installation angle exceeds 30 from horizontal, the unit might not give its optimum performance. Avoid installing the unit where it would be subject to high temperature such as from direct sunlight. Lower case or from hot air, from the heater, or where it would be subject to dust, dirt or excessive vibration.

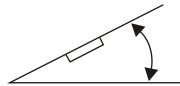

DIN FRONT/REAR-MOUNT

This unit can be properly installed either from "Front" (conventional DIN Front-mount) or "Rear" (DIN Rear-mount installation, utilizing threaded screw holes at the sides of the unit chassis). For detail, refer to the following illustrated installation methods.

DIN FRONT-MOUNT (Method A)

Installing the unit

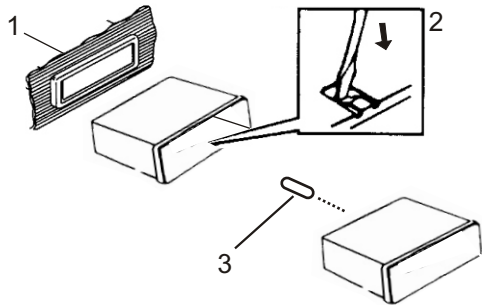

- Dashboard
- Holder
After inserting the holder into the dashboard, select the appropriate tab according to the thickness of the dashboard material and bend them inwards to secure the holder in place.
- Screw

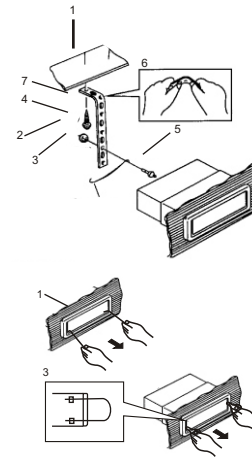

- Dashboard
- Nut (5mm)
- Spring washer
- Screw (5 x 16mm)
- Screw
- Strap
Be sure to use the strap to secure the back of the unit of the place. The strap can be bent by hand to the desired angle.
- Plain washer

- Frame
- Insert fingers into the groove in the front of frame and pull out to remove the frame. (When re-attaching the frame. Point the side with a groove downwards and attach it.)
- Lever
Insert the levers supplied with the unit into the grooves at both sides of the unit as shown in figure until they click. Pulling the levers makes it possible to remove the unit from the dashboard.

4 SPEAKER WIRING

CONNECTIONS

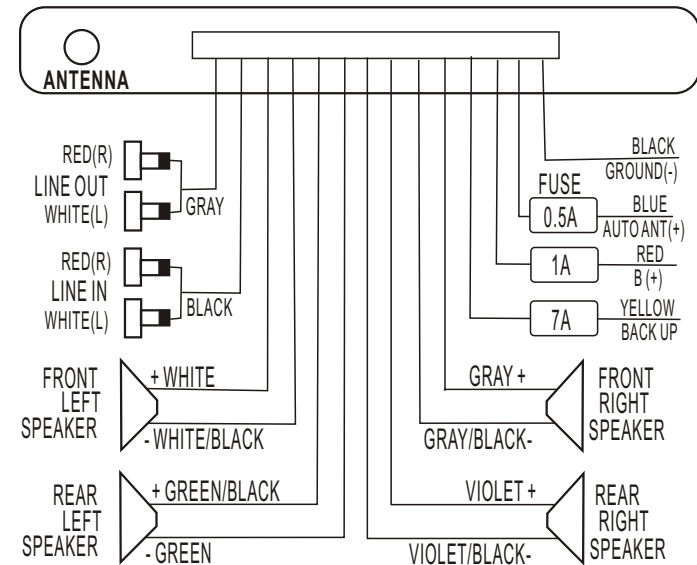

USING THE RESET BUTTON

Press button with a thin, pointed object if unit is malfunctioning. Though not a normal occurrence, the microprocessor which controls the operation of this unit can be affected by electrostatic noise.

This generally is indicated by such symptoms as no power being supplied when you switch the unit on, failure of buttons and controls, or an abnormal display.

Should this happen, press the reset button with a thin, pointed object to reset the microprocessor.

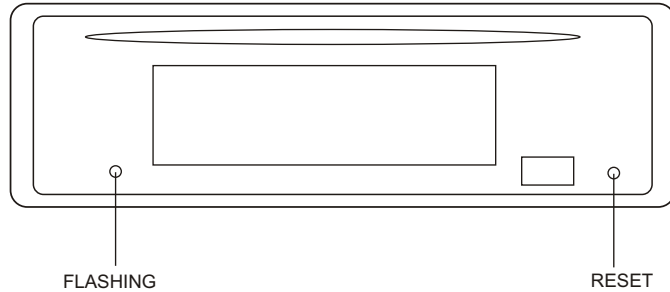

SPECIFICATIONS

MW(AM) SECTION

Frequency Range	: 530 - 1710 KHz
Channel Step	: 10 KHz
Intermediate Frequency	: 450 KHz
Usable Sensitivity	: 33 dB
Image Rejection Ratio	: >50 dB
If Rejection Ratio	: >50 dB

FM SECTION

Frequency Range	: 87.5-107.9 MHz
Channel Step	: 200 KHz
Intermediate Frequency	: 10.7 MHz
Image Rejection Ratio at 106KHz	: >50 dB
Signal to noise ratio	: >60 dB

CD PLAYER SECTION

Signal to noise Radio	: More than 60dB
Channel separation	: More than 60dB
Frequency Response	: 20Hz - 20KHz

GENERAL

Power Supply Voltage	: DC 12 Volts Negative Ground
Speaker impedance	: 4Ω - 8Ω
Maximum Output Power	: 15W x 4CH
Dimensions Chassis	: 178(W) x 50 (H) x 160(D)mm